

CAD Workbook 2008

Name: _____

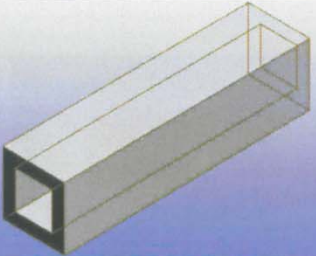
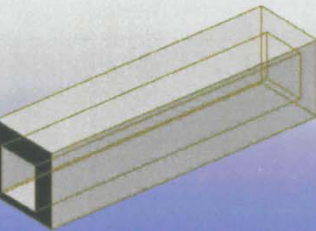
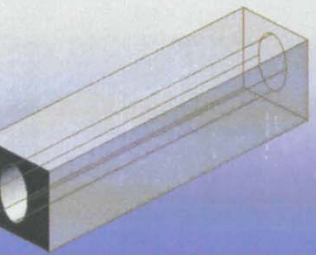
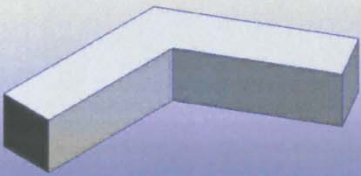
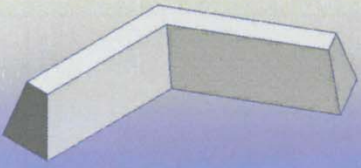

Example 1		
Example 2		
Example 3		
Example 4		

Example 5		
Example 6		
Example 7		
Example 8		
Example 9		

Example 10

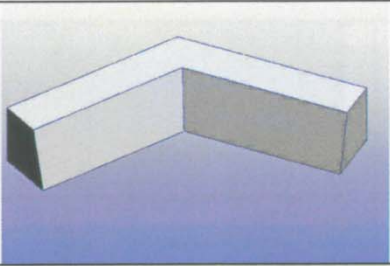

Example 11

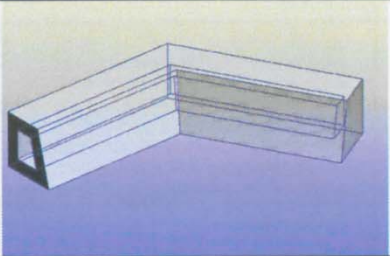

Example 12

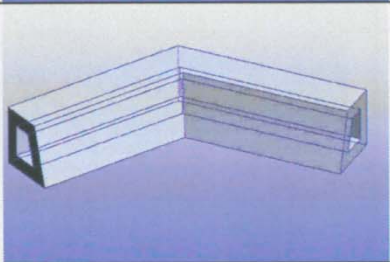

Example 13

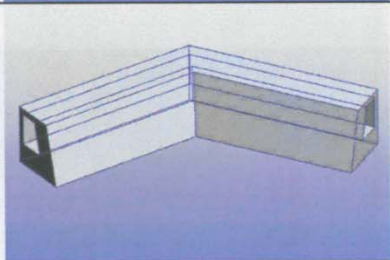

Example 14

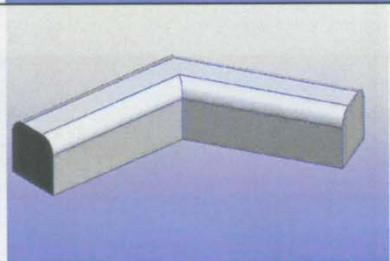

Example 15		
Example 16		
Example 17		
Example 18		

Example 19

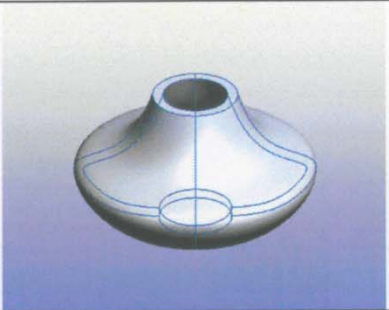

Example 20

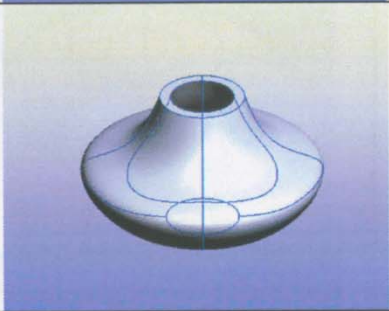

Example 21

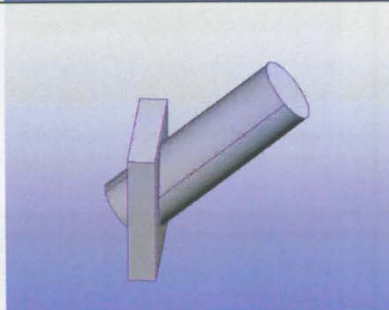

Example 22

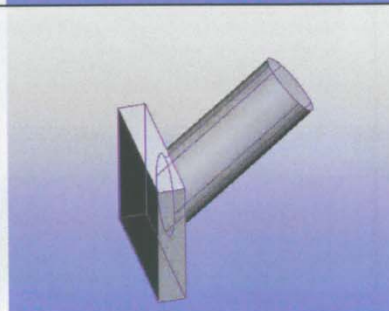

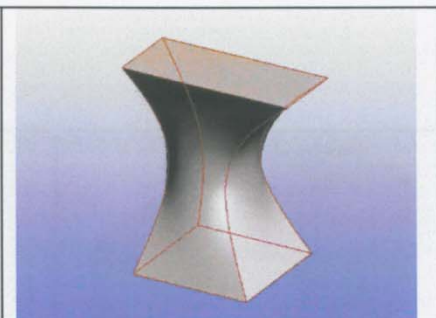
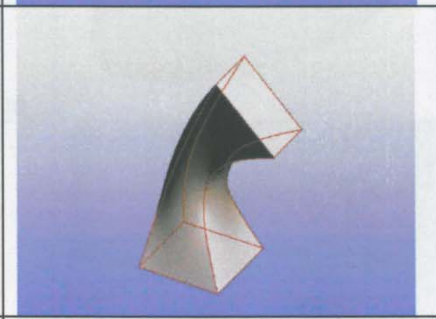
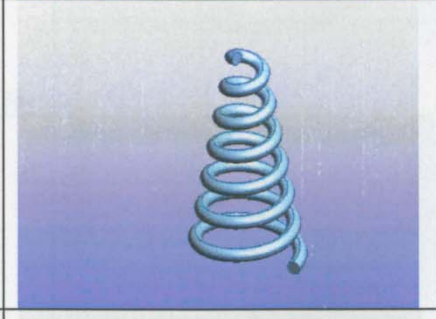
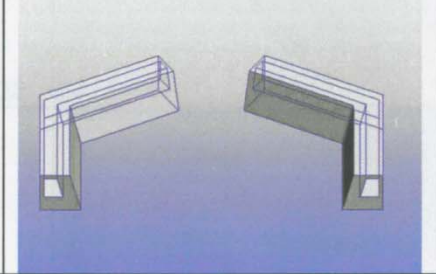
Example 23		
Example 24		
Example 25		
Example 26		

Example 27

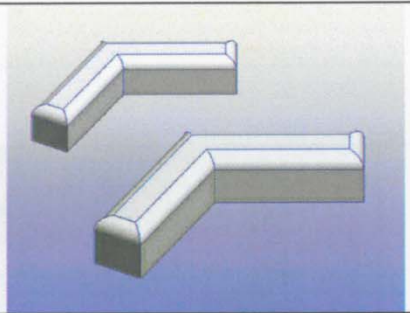

Example 28

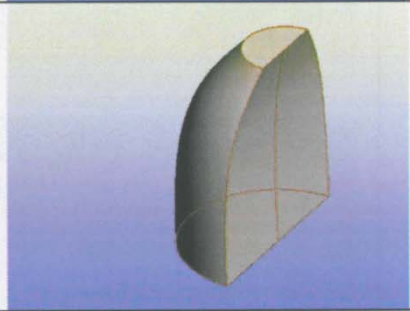



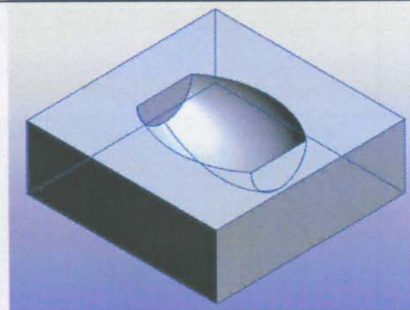

Example 29

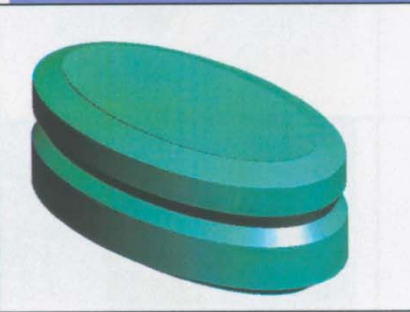

Example 30

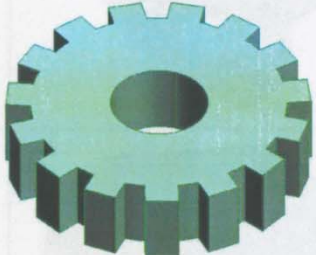



Example 31		
Example 32		
Example 33		
Example 34		



Example 35

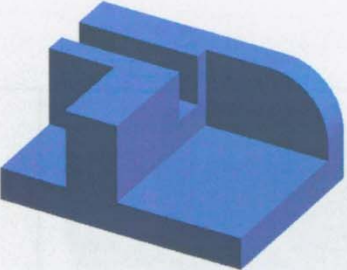
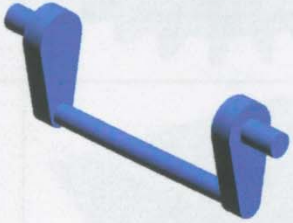

Example 36

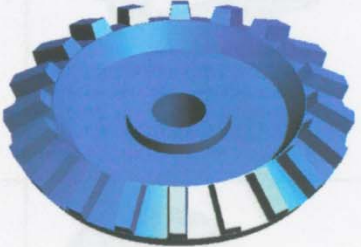

Example 37		
Example 38		
Example 39		
Example 40		

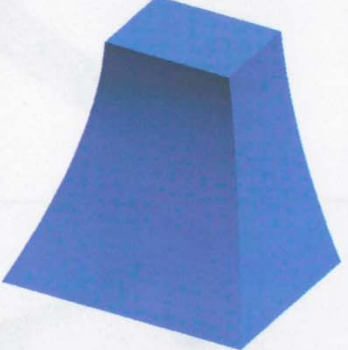
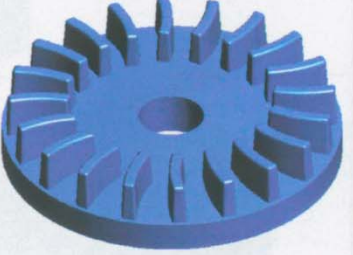
Example 41		
Example 42		
Example 43		
Example 44		

Example 45

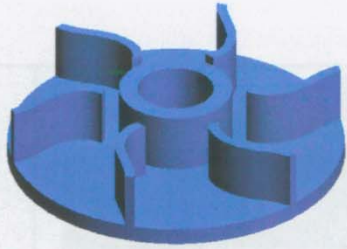

Example 46

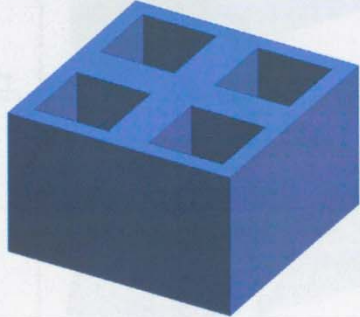

Example 47



Example 48



Example 49



Example 50

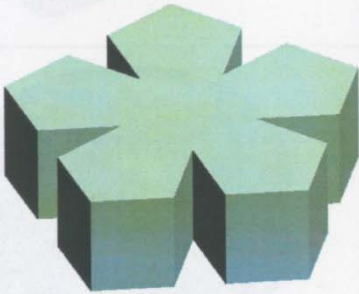

Example 51

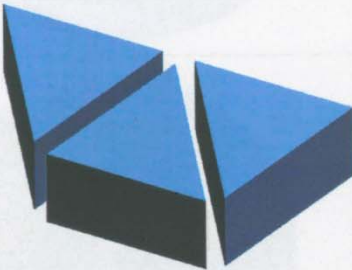

Example 52

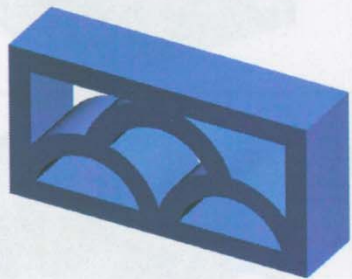

Example 53

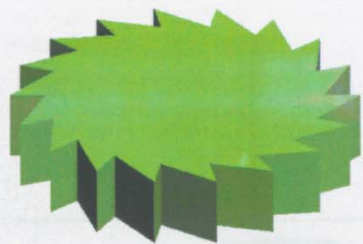

Example 54

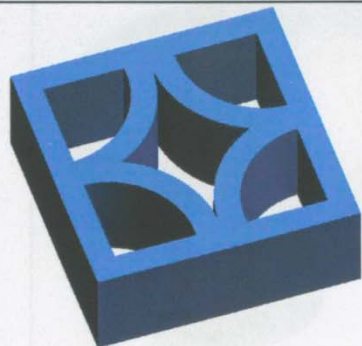

Example 55



Example 56

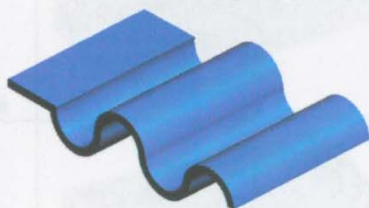

Example 57



Example 58

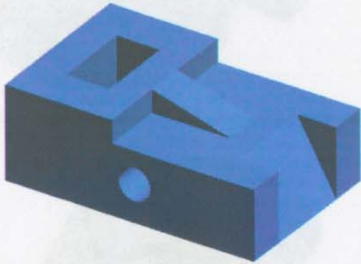

Example 59



Example 60

